

Quality Heat Exchangers



Türkiye Yetkili Satış ve
Servis Distribütörü

Shell-and-tube heat exchangers

Standard series and customer oriented solutions



With partnership into the future

FUNKE is a leader in the development and production of quality heat exchangers with a heat transfer area of up to 2400 m². The range of products comprises shell-and-tube heat exchangers, bolted and brazed plate heat exchangers as well as oil / air cooling units and electrical oil pre-heaters. Thus, as one of the few producers worldwide, FUNKE offers solutions with optimum thermodynamic designs for different industries and virtually all applications.

FUNKE focuses on customer orientation, highest quality standards, flexibility and advisory skills – important benefits a company of just the right size is able to offer.



Put the pressure on – quality shell-and-tube heat exchangers

In the area of shell-and-tube heat exchangers FUNKE has a mature product range of special models for almost all requirements in machine and plant engineering. Maximum quality requirements and customer oriented solutions characterise the brand FUNKE. Thus, for example, customised process gas coolers with operating pressure of 600 bar and above are not unusual for our production. However, already with our series models we already offer our customers with our standard programme a comprehensive and high quality range of products for all common require-

ments in international machine and plant engineering. The customer receives thermodynamically optimised units which are manufactured in defined graduations e.g. with regard to shell diameter and shell-and-tube length and which are available at short notice.

Basic technical data (depending on design)			
Performance	1 KW	up to	30 MW
Transfer surface	0,11 m ²	up to	2.000 m ²
Shell diameter	60 mm	up to	2.000 mm
Operating temperature	-20°C	up to	500°C
Operating pressure	max. 600 bar		

- FUNKE shell-and-tube heat exchangers**
- Straight tube / U-shaped tube / safety heat exchangers
 - in all common construction types
 - for all common liquid and gaseous media

Series models	Individual solutions
---------------	----------------------

- TDW, BCF, CCFA, SWF, CPS, WRA 200**
- preselected apparatus geometries provide for:
- short delivery periods
 - excellent price / performance ratio
 - proven models provide for reliability

- CP, A 100, C 100 ... C 500**
- consistent implementation of customer requirements:
- company specification
 - standards of engineering companies
 - international design standards

Advantages of the FUNKE shell-and-tube heat exchangers (RWT):

- order-specific solutions and mature standard model series according to all world wide important directives and standards (such as PED, ASME, TEMA, API)
- optimum designs with internationally leading calculation software (e.g. HTRI)
- reliable heat transfer even with critical media
- very high operating pressures and operating temperatures possible
- low tendency to foul due to optimised flow behaviour
- high degree of safety with regard to mixing of media
- robust and high quality designs
- low capital investment, operating and maintenance costs relative to the overall service life
- easy to open / clean

Structure and function

The shell-and-tube heat exchanger is a non-fired pressure system consisting of two separate pressure chambers (shell chamber and tube chamber). Separated by the internal tube wall, two media flow past one another with such alignment that, if there is a temperature difference, they will mutually exchange heat without mixing in the process. As the picture shows, one medium flows through the shell chamber and the second medium flows through the tube chamber. The flow through the shell chamber is controlled by baffles such that there is as much crossflow to the tubes as possible. The form and spacing of the baffles is adapted to the relevant operational use.

Depending on effectiveness, speed and pressure loss the flow through the tube chamber is effected by a single pass or by multiple passes. With the exception of radiation losses, the input heat quantity is the same as the output heat quantity.

- Components of the shell-and-tube heat exchanger**
- | | |
|------------------------|------------------|
| 1 Heat exchanger shell | 5 Tubesheets |
| 2 Connection chamber | 6 Baffles |
| 3 Guide chamber | 7 Apparatus seal |
| 4 Internal tubes | |

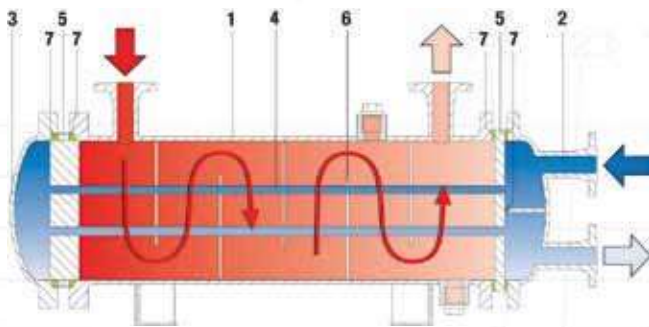

However, an effective heat exchange can only take place if the temperature difference is sufficient. The greater the temperature difference, the smaller will be the required heat transfer surface. The heat transfer performance of a heat exchanger is the product of the mean logarithmic temperature difference, the heat transfer surface and the heat transfer coefficient. The latter is largely determined by the flow characteristics of the media, that is by the geometric design.

On the other hand, the supplier of heat exchangers must have a wide application know-how with regard to the thermodynamic properties of special media at pertinent pressures and temperatures. This also applies for the issues fouling factor and material compatibility.

The calculation and design of FUNKE heat exchangers is effected with worldwide leading programs (e.g. HTRI, Heat Transfer Research Institute, USA) and with FUNKE-Software which is already used internationally.

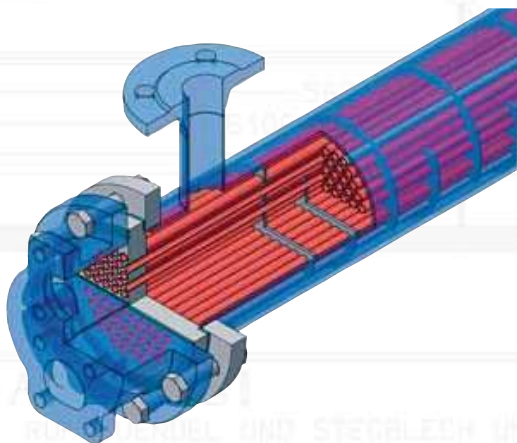

Model series BCF/P, CCF/P, SSCF/P Universal

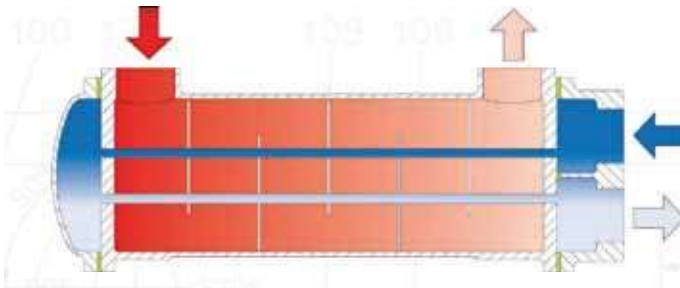

Technical Description

Model series for universal use in modular system construction with exchange surfaces of 0.11 m² to 11.45 m². 110 graduated building sizes in three principal material groups with two possible construction designs respectively (fixed tube bundle or removable tube bundle) provide the basis for an optimum and detailed type selection:

Whilst the versions with a fixed tube bundle are available in a tube side single-pass, two-pass or four pass version, the versions with a removable tube bundle are for design reasons only available in a tube side single-pass or two-pass version. The subdivision of the tube bundle geometry into an O-version and a W-version offers excellent possibilities for the optimisation of heat transfer and pressure losses: In the O-version a narrow baffle spacing produces an excellent heat transfer at low pressure losses. This version is to be selected preferably for thin liquid operating media. The W-version, with its wide baffle spacing, implements the compromise between an excellent heat transfer and acceptable pressure losses. Due to the bundle geometry, favourable in fluid engineering terms, this version is particularly suitable for viscid operating media. All types of this standard series are available in horizontal or upright version. When using internal tubes made of CuZn28Sn F32, CuZn20 Al F34, CuNi30Fe F37 and SF-Cu, as standard the tube bundle heat exchangers of type BCF, BCP, CCF and CCP are equipped with sacrificial anodes in order to extend the operating periods or service life of the apparatus. These sacrificial anodes made of tin (tin protection rod) are screwed with a square into the tube side connection

chambers, using a 3/8" NPT thread. The blind hole bore provided becomes a through hole on complete breakdown of the anode and signals the point in time when replacement is required. As standard, no production drawing is supplied for this model series.

Application

Very wide range of application for all current heat engineering tasks. In accordance with the requirements due to the operating media and environmental conditions these types are frequently used as fluid coolers for oil, water or other operating fluids. The operation with steam is only possible on the shell side and subject to restrictions. Contaminated operating media must preferably be led through the tubes. A high velocity of flow which is to be aimed for is possible due to the multi-pass design.

Standard documentation

see TDW on page 6

Additional possible special versions

- Baffle spacing type "B" deviating from the O- or W-versions
- Thread connections with NPT-thread
- SAE flanges

Acceptance

The FUNKE heat exchangers of this model series correspond to the Pressure Equipment Directive 97/23/EC (PED) pursuant to article 3, paragraph 3 and therefore are never given a CE mark.

Exception:

For the shell-and-tube heat exchangers of type BCF (horizontal installation) there is an EC type approval test pursuant to module B of Pressure Equipment Directive 97/23/EC according to which these types can be supplied with CE marking.

Other national or international design regulations (e.g. AD-2000, ASME) are not applicable.

Component	Material standard*			Remarks
	BCF/BCP	CCF/CCP	SSCF/SSCP	
Internal tubes	CuZn28Sn1 F32	St35, St35.8I	1.4571	
Tubesheets	CuZn40Pb2 (CW617N)	GS 45	1.4408	
Baffles	CuZn37 (CW508L)	1.4571	1.4571	
Shell	CuZn37Pb0.5 (CW604N)	St35.8I	1.4571	
Connection chambers, Foot	EN-GJL-200	EN-GJL-200	1.4408	
Seals	Klinger C4400, Arostat 6204	Klinger C4400, Arostat 6204	Klinger C4400, Arostat 6204	
Coat of paint	RAL 5012, light blue	RAL 5012, light blue	pickled and passivized	
Angular feet	S235JRG2	S235JRG2	1.4571	
Insulation	Mineral wool galvanized with steel sheet	Mineral wool galvanized with steel sheet	Mineral wool with stainless steel sheet	Only in combination with angular feet

* Optional materials for these model series are to be found on page 5. The dimensions of these model series are contained on the dimension sheet.

Media routing	Max. operating overpressure	Test overpressure	Max. operating temperature			
Shell side	16 bar	24 bar	BCF 150°C	BCP 110°C	CCF/P 110°C	SSCF/P 110°C
Tube side	8 bar	15 bar				

Optional materials for the model series BCF/P, CCFP, SSCF/P

Component	BCF/BCP	CCF/CCP	SSCF/SSCP
Internal tubes	CuZn20Al F34, CuNi30Fe F37, SF-Cu F22 (F25), 1.4571	1.4571, CuNi30Fe, CuZn20Al F34	
Tubesheets	CuZn39Pb3	P265GH as a fixed tubesheet as well as 1.4571 as a floating tubesheet for the P version	1.4571 in the case of the P version
Baffles			
Shell	Flange connections screwed in on the shell side	Flange connections screwed in on the shell side	Flange connections screwed in on the shell side
Connection Chambers, Stand	Plastic coating, G-CuSn10 (Cast bronze) ¹⁾	Plastic coating, G-CuSn10 (Cast bronze) ¹⁾	⁴⁾
Seals	PTFE, Viton	PTFE, Viton	PTFE, Viton
Coat of paint	Other RAL colours ²⁾	Other RAL colours ²⁾	
Angular feet	Clamp feet made of S235JRG 2	Clamp feet made of S235JRG2	Clamp feet made of 1.4571
Insulation	³⁾	³⁾	³⁾

¹⁾Foot not made of G-CuSn10

²⁾ Priming coat

³⁾ Only in combination with angular feet

⁴⁾ Foot only made of EN-GJL-200

BCF	Brass	fixed tube bundle (F)
CCF	Carbon Steel	fixed tube bundle (F)
SSCF	Stainless Steel	fixed tube bundle (F)
BCP	Brass	removable tube bundle (P)
CCP	Carbon Steel	removable tube bundle (P)
SSCP	Stainless Steel	removable tube bundle (P)

Model series TDW Turbo-Spin

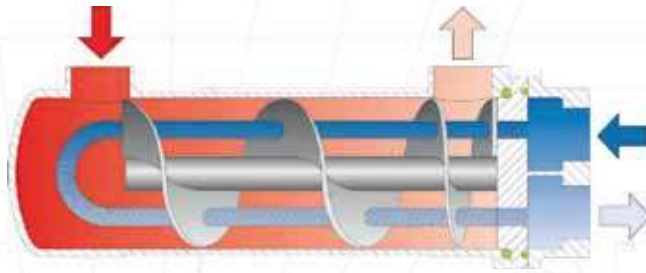

Technical Description

The FUNKE heat exchangers from the TDW series (Turbo-Spin heat exchangers) are very compact heat exchangers with an removable tube bundle, which were developed for the cooling of hydraulic oils or hydraulic replacement fluids* (see table). Exchanger surfaces from 0.15 m² - 4.00 m² can be installed in fixed and reasonably graduated building sizes. The thermotechnically highly efficient spin-shaped oil flow on the shell side is generated by the arrangement of special helical screws whose pitch can be adapted to the flow quantity.

Two versions are available: With the O version (low helical screw pitch) for liquid oils and the W version (high helical screw pitch) for viscid oils, compromises are provided between an optimum heat transfer and pressure loss. The oil end tin-plated ribbed tubes bent into U-shape are fixed by means of helical screws and also are moulded leakage free into the tubesheet made of synthetic material. The sealing of the fixed tubesheet between heat exchanger shell and connection chamber is effected by means of O rings. Due to the multipass design on the tube side good velocities of flow are reached even with small quantities of cooling water; these counteract a possible fouling of the interior tube wall. All connections at the shell-and-tube end are designed with a Whitworth internal tube thread (G).

Application

Wherever a safe and uncomplicated oil cooling system is required. The integration in oil supply systems or drive and control units represent only some of the many possibilities.

Standard documentation

The standard documentation for these shell-and-tube heat exchangers comprises:

- Operating and maintenance instructions
- Pressure test certificate
- Declaration of conformity / Certificate of conformity

Additional possible special versions

- Tank installation version as TDWT
- Filter oil cooler as TDWF
- Oil connections with square flanges incl. seals and bolts

Acceptance

The FUNKE heat exchangers of series TDW correspond to the Pressure Equipment Directive 97/23/EC (PED) pursuant to article 3, paragraph 3 and therefore are **not given** a CE mark.

Component	Material standard	Material optional	Material hydraulic replacement fluids*
Internal tubes	Cu-DHP-R250, tin-plated on the oil contact side	CuNi10Fe, tin-plated on the oil contact side	
Tubesheets	Synthetic material with Al-composite material		
Helical screws	GD-ZnAl4Cu1		tin-plated*
Shell	AlMgSi0, 0,5F22		
Connection chamber	B-AISI10Mg		
Seals	NBR		
Coat of paint	RAL 5012, light blue		
Clamp-type feet	St 37		

* The type designation is given the addition "HS" [Example: TDW 5510-0 HS]. The dimensions of these model series are on the dimension sheet.

Media routing	Max. operating overpressure	Test overpressure	Max. operating temperature
Shell side	16 bar	21 bar	100°C
Tube side	8 bar	11 bar	100°C

Model series CCFA, SSCFA

Gas cooling

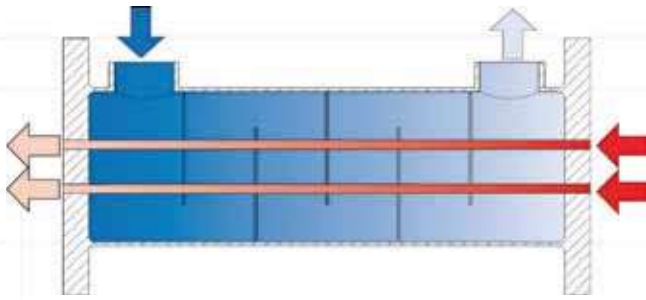

Technical Description

The heat exchanger CCFA (SSCFA in stainless steel version) is a further development of the proven heat exchanger model series BCF for use as a gas cooler.

The CCFA has been designed with a fixed tube bundle and is only available as a tube side single-pass version (gas flowing through the tubes), thus it can easily be integrated into the gas pipework.

The cooling water is routed on the shell side in a counter-flow direction. Optionally a horizontal or vertical fitting position is possible.

In the event of condensate occurring there is the option of precipitation and phase separation by the downstream connection of a condensate separator (cyclone separator). Here, however, attention should be paid to a suitable fitting position.

Application

The operational range of these heat exchangers as air or gas coolers is very wide and varied. For example, they are used in connected plants with multi-stage compressors as intermediate coolers or after coolers and as individual coolers wherever compressed gases need to be cooled but also dried. Gas preheating with suitable heating media is also possible.

Standard documentation

see TDW on page 6

Additional possible special versions

If required, the shell-and-tube heat exchangers of type CCFA/SSCFA are also available for higher operating pressures and other design regulations.

Acceptance

The FUNKE heat exchangers of type CCFA/SSCFA are supplied in compliance with the Pressure Equipment Directive 97/23/EC (PED) and in accordance with the AD 2000 regulations.

Component	Material CCFA	Material SSCF	Optional
Internal tubes	1.4571	1.4571	CuNi30Fe in the case of type CCFA
Tubesheets or connection flange	P 265 GH	1.4571	mating flanges, seals and bolts
Baffles	1.4571	1.4571	
Shell	St35.8l	1.4571	
Clamp-type feet	S235JRG2	1.4571	
Coat of paint	RAL 5012, light blue	pickled and passivated	other RAL shades at CCFA

The dimensions of these model series are on the dimension sheet.

Media routing	Max. operating overpressure	Test overpressure	Max. operating temperature
Shell side	16 bar	24 bar	230°C
Tube side	10 bar	15 bar	230°C

Model series SWF / SWP, SSWF / SSWP

Safety

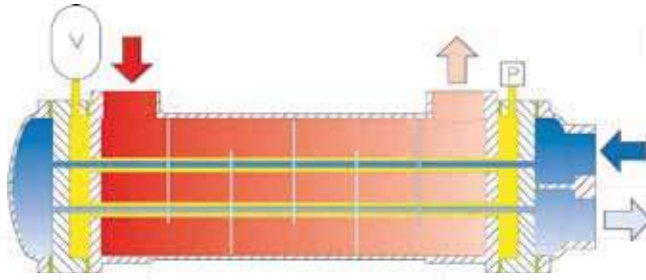

Technical Description

SWF safety heat exchangers are designed as three chamber devices with straight internal tubes and fixed (F) or removable (P) tube bundle.

In each individual internal tube of the tube bundle a further smaller internal tube is installed. These concentric internal tube pairs form radial gaps which are interconnected by the design of the double tubesheets and thus produce the enclosed safety space. A mixing of the flowing operating media is prevented in this way.

This sealed safety space is filled with a special barrier fluid and is checked for pressure changes by means of a pressure control device.

In order to prevent any increases in pressure and thus a false alarm due to thermal expansion of the barrier fluid, the safety space is additionally fitted with an equalizing vessel.

In the case of a leakage of the shell or tube sides the corresponding pressure change within the safety space will be detected by the pressure control device and signalled accordingly.

Application

FUNKE safety heat exchangers are used wherever a leakage or mixing of both operating media is not acceptable during fluid cooling or fluid heating.

Selection criteria may be:

- Environmental protection (e.g. cooling water removal from surface waters)
- Health protection (e.g. reactions between both operating media)
- Costs of operating resources (e.g. disposal of contaminated fluids and refilling)

Material selection

The material selection for the standard safety heat exchangers SWF (size 300 - 808*) can be found in the description for the model series BCF/P, CCF/P and SSCF/P (see page 5), they apply mutatis mutandis. The materials for SWF devices from size 1003 change in accordance with the table below.

Additional possible special versions

If required, the shell-and-tube heat exchangers of type SWF/P and SSWF/P are also available for other materials, higher operating pressures and other construction regulations. Delivery with pressure control devices according to ATEX and an extended documentation is possible.

Acceptance

The FUNKE safety heat exchangers of type SWF/P and SSWF/P are supplied in compliance with the Pressure Equipment Directive 97 / 23 / EC (PED) and in accordance with the AD 2000 regulations.

Standard documentation

The standard documentation for these shell-and-tube heat exchangers comprises:

- Operating and maintenance instructions
- Pressure test certificate
- Declaration of conformity / Certificate of conformity

For size 300 - 808, no production drawing will be prepared.

Component	Material SWF/P	Material SSWF/P	Options
Shell	St35.8l	1.4571	possible
Tubesheets	P 265 GH	1.4571	possible
Angular feet	RSt37-2	1.4571	
Coat of paint	RAL 5012, light blue	pickled and passivized	other RAL shades at SWF/P

The dimensions of these model series are on the dimension sheet.

Media routing	Max. operating overpressure	Test overpressure	Max. operating temperature
Shell side	16 bar	24 bar	150°C
Tube side	10 bar	15 bar	150°C

Model series CPS Standard

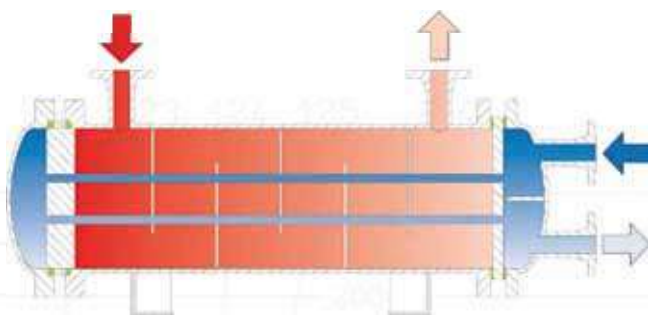

Technical Description

The CPS-(CP-Standard) model series was developed on the basis of the TEMA type BEW and represents a delimitation relative to customized individual solutions, achieved by reasonable standardization. Systems with a heat exchanger surface of 0.47 m² - 104.02 m² can be realized at a very economical price/performance ratio and with the known FUNKE quality.

The CPS has straight internal tubes and an removable tube bundle whose fixed tubesheet is clamped in between the shell side and tube side device flanges by means of two flat seals and bolts.

On the side of the floating movable tubesheet, the combination of two sealing rings and a leakage ring between the device flanges protects against a mixing of the shell side and tube side flowing media.

In the case of leakages due to a single or both sealing rings being defective the pertinent media always escape towards the outside through signal bores on the circumference of the leakage ring.

All seals of this design seal against atmosphere.

The tube/tubesheet connections are produced exclusively by roll expansion.

There are two versions of the connection and guide chambers available by means of which a tube side single-pass or two-pass version can be generated and whose selection is effected according to fluid engineering criteria.

Application

The operational use of this heat exchanger as a fluid cooler is wide and varied. It is predominantly used as a standard oil cooler or water cooler. The use as a gas cooler or gas preheater can be implemented by means of the media routing "Gas through tubes".

Acceptance

The FUNKE heat exchangers of type CPS are supplied in compliance with the Pressure Equipment Directive 97/23/EC (PED) and in accordance with the AD 2000 regulations.

Standard documentation

The standard documentation for these shell-and-tube heat exchangers comprises:

- Production drawing
- Calculation of stability
- Operating and maintenance instructions
- Pressure test certificate
- Declaration of conformity / Certificate of conformity

Component	Material	Optionen	Remarks
Internal tubes	CuZn28Sn1F32	Refined steel, 1.4571	
Tubesheets	CuZn38SnAlF39	Refined steel, 1.4571	
Baffles	CuZn37	Refined steel, 1.4571	
Shell	St35.8l		
Connection / Guide chamber	P 265 GH (St35.8l)		
Clamp-type feet	S235JRG2		
Coat of paint	Zinc phosphate primer		grey / green

The dimensions of these model series are on the dimension sheet.

Media routing	Max. operating overpressure	Test overpressure	Max. operating temperature
Shell side	20 bar	According to PED	110°C
Tube side	10 bar	According to PED	80°C

Model series WRA 200 Exhaust gas

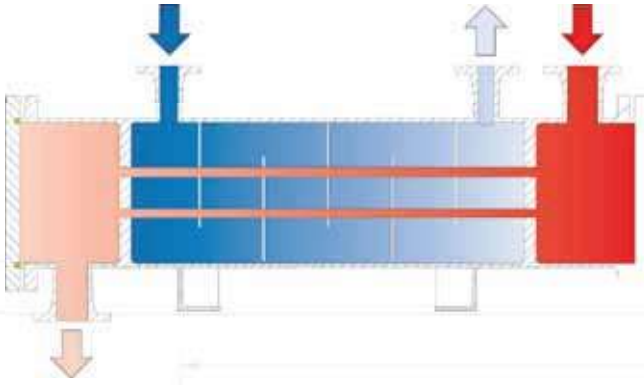

Technical Description

The model series WRA 200 represents a special design for exhaust gas cooling. The principle of media routing here is: "Exhaust gas through the tubes", with tube side single-pass execution being selected exclusively. The heat exchanger has straight "internal" tubes and a fixed non-removable tube bundle whose shell tube is welded to the tubesheets such that the joint is tightly sealed. Due to its design, the WRA 200 can be equipped with a maximum possible and optimum tubing. The tube/tubesheet connections are produced by pertinent tube weldings in accordance with the construction regulations and material combinations as well as the maximum permissible operating parameters (P/T). Naturally, to avoid gap corrosion, after a tube welding the internal tubes are roll expanded again. Maximum exhaust gas temperatures at the gas entry side will be transferred without any hazard and without any detrimental effect on the service life as a thermal shield protects the tube/tubesheet connections against overheating and heat accumulation, and thus prevents material fatigue or cracking in the tubesheet.

To prevent the generation of non-permissibly high axial forces due to thermal length changes, caused by different operating states and/or material selection, an axial compensator can be installed in the casing tube. Both connection chambers of the exhaust gas side are equipped with inspection covers for easy cleaning of the internal tubes without disassembly of the exhaust gas lines.

Application

The WRA 200 was specially developed for heat recovery from the exhaust gases of stationary combustion engines in block-type thermal power stations. Depending on the fuel used as e.g. diesel, natural gas, digester gas, rapeseed-, or vegetable oil the materials and internal tube dimensions can be adapted according to customer requirements.

Material selection

In accordance with the respective regulations and construction regulations, stainless steels are used for the internal tubes, tubesheets and baffles as well as for the outlet gas chamber. The inlet gas chamber and the casing tube are manufactured from carbon steel. An integration of other material combinations or the use of special materials is possible.

Acceptance

The FUNKE heat exchanger of type WAR 200 can be supplied in accordance with all pertinent national and international certification bodies, regulations and construction regulations as e.g. pursuant to the Pressure Equipment Directive (PED), AD-2000, ASME-VIII, Div. I, U-Stamp, TEMA standard, CHINA-SQL. The integration of works standards or customer specifications is no problem either.

Standard documentation

The standard documentation for these shell-and-tube heat exchangers comprises:

- Operating and maintenance instructions
- Pressure test certificate
- Declaration of conformity / certificate of conformity

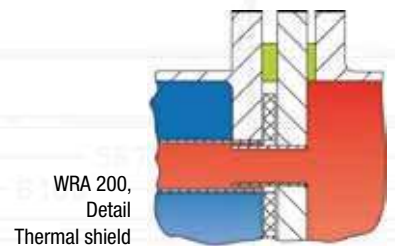

Component	Material	Optional	Remarks
Internal tubes	Refined steel, 1.4571	St35.8l	
Tubesheets	Refined steel, 1.4571		
Baffles	Refined steel, 1.4571		
Shell	St35.8l		
Connection chamber gas inlet	St35.8l/P 265 GH		
Connection chamber gas outlet	Refined steel, 1.4571		
Coat of paint	Silicon aluminum colour		Refined steel pickled / passivized

The dimensions of these model series are on the dimension sheet.

Media routing	Max. operating overpressure	Test overpressure	Max. operating temperature
Shell side	10 bar		150°C
Tube side	0,5 bar*		550°C

* Calculation overpressure 6 bar

Universal cooler, tube bundle removable

Model series CP (e.g. TEMA Type BEW; AEW)

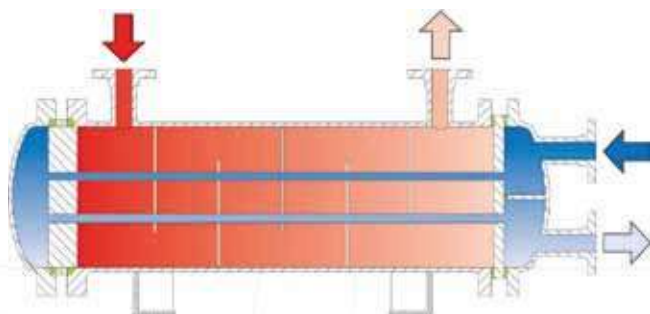

Technical Description

The FUNKE heat exchanger type CP is a heat exchanger with straight internal tubes and removable tube bundle whose fixed tube-sheet is clamped in between the shell side and tube side device flanges by means of two flat seals and bolts. The movable tubesheet, floating due to the combination of two sealing rings and a leakage ring between the device flanges, protects against a mixing of the shell side and tube side flowing media.

In the case of leakages due to a single or both sealing rings being defective the pertinent media always escape towards the outside through signal bores on the circumference of the leakage ring. All seals of this design seal against atmosphere.

The tube/tubesheet connections are produced by appropriate tube expand rollings or tube weldings in accordance with the construction regulations, material combinations and operating media as well as the maximum permissible operating parameters (P/T). Naturally, to avoid gap corrosion, after a tube welding the internal tubes are roll expanded again.

The connection and guide chambers are available in different versions, which can be produced by a tube side single-pass, two-pass or four pass design and whose selection is effected in accordance with the standards required and with fluid engineering aspects.

Venting and draining points as well as a corresponding foot construction are designed in relation to the installation position.

Material selection

In accordance with the respective regulations, construction regulations and operating media, carbon steels, stainless steels as well as non-ferrous heavy metals are used. A reasonable integration of special materials, platings and coatings is possible.

Application

This heat exchanger type CP is mainly used as an oil cooler or double oil cooler, where the oil should flow on the shell side whilst the cooling water flows through the internal tubes. This heat exchanger is used also for cooling other fluids as well as air or similar gases with and without any condensable content. Any operation with gases having a low molecular weight (e.g. hydrogen) is not effective due to the type of seal used on the floating tubesheet.

Acceptance

The FUNKE heat exchanger of type CP can be supplied in accordance with all pertinent national and international certification bodies, regulations and construction regulations as e.g. pursuant to the Pressure Equipment Directive (PED), AD-2000, ASME-VIII, Div. I, U-Stamp, TEMA standard, API 614/618, CHINA-SQL. The integration of works standards or customer specifications is no problem either.

Boundary conditions

Due to its design and sealing type the maximum permissible operating conditions* are

	Shell side	Tube side
Maximum operating overpressure	41 bar	41 bar
Maximum operating temperature	250°C	250°C

* The maximum values may reduce due to regulations, works standards and construction regulations!

Gas cooler, tube bundle removable Model series A 100 (e.g. TEMA Type BEW; AEW)

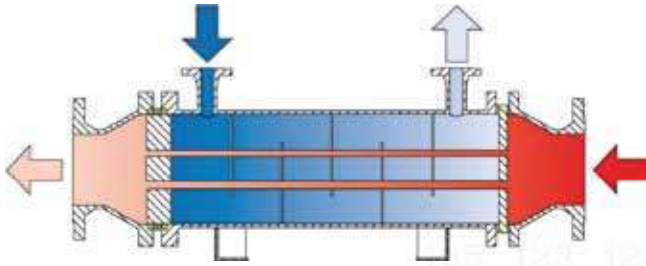

Technical Description

The FUNKE heat exchanger type A 100 was designed in accordance with type CP and is exclusively available as a gas cooler - media routing "gas through the tubes" – in a tube side single-pass version. It is a heat exchanger with straight internal tubes and a removable tube bundle whose fixed tubesheet is clamped in between the shell side and tube side device flanges by means of two flat seals and bolts. The movable tubesheet, floating due to the combination of two sealing rings and a leakage ring between the device flanges, protects against a mixing of the shell side and tube side flowing media. In the case of leakages due to a single or both sealing rings being defective the pertinent media always escape towards the outside through signal bores on the circumference of the leakage ring. All seals of this design seal against atmosphere.

The tube/tubesheet connections are produced by appropriate tube expand rollings or tube weldings in accordance with the construction regulations, material combinations and operating media as well as the maximum permissible operating parameters (P/T). Naturally, to avoid gap corrosion, after a tube welding the internal tubes are roll expanded again.

The connection chambers are available in various different versions whose selection is effected in accordance with the required standards and in accordance with fluid engineering aspects.

Venting and draining points as well as a corresponding base construction are designed in relation to the installation position.

Material selection

In accordance with the respective regulations, construction regulations and operating media, carbon steels, stainless steels as well as nonferrous heavy metals are used. A reasonable integration of special materials, platings and coatings is possible.

Application

This heat exchanger type A 100 is exclusively used for cooling and drying air or similar gases, with the gas flowing on the tube side and the cooling water flowing within the shell space around the internal tubes.

Any operation with gases having a low molecular weight (e.g. hydrogen) is not effective due to the type of seal used on the floating tubesheet.

If partial condensation occurs, a cyclone separator for phase separation may be flanged directly to the outlet chamber, if required.

Acceptance

The FUNKE heat exchanger type A 100 can be supplied in accordance with all pertinent national and international certification bodies, regulations and construction regulations as e.g. pursuant to the Pressure Equipment Directive (PED), AD-2000, ASME-VIII, Div. I, U-Stamp, TEMA standard, CHINA-SQL. The integration of works standards or customer specifications is no problem either.

Boundary conditions

Due to its design and sealing type the maximum permissible operating conditions* are

	Shell side	Tube side
Maximum operating overpressure	41 bar	41 bar
Maximum operating temperature	250°C	250°C

* The maximum values may reduce due to regulations, works standards and construction regulations!

ACHTUNG!

ROHRBÜNDEL UND STEGBLECH UM 90° GEHRECHT
DEZEIGNET.
LAGE SIEHE SEITENANSICHT.

ATTENTION!

TUBEBUNDLE AND PASS PARTITION PLATE DRAWN
AT 90° TURNED,
POSITION SEE SIDEVIEW.

Universal cooler, tube bundle removable

Model series C 100 (e.g. TEMA Type BEP/AEP)

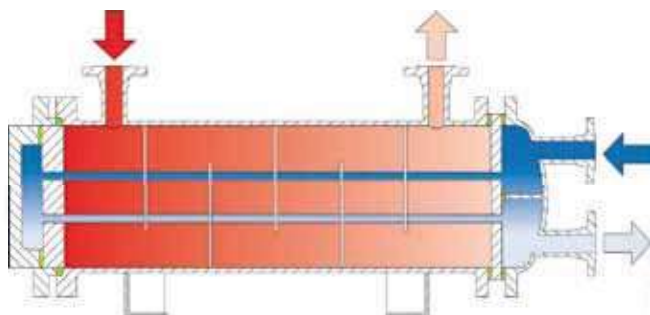

Technical Description

The FUNKE heat exchanger type C 100 is a heat exchanger with straight internal tubes and removable tube bundle whose fixed tubesheet is clamped in between the shell side and tube side device flanges by means of two flat seals and bolts.

The combination "gland-packing ring-stuffing box gland" positions the movable tubesheet so that it is floating within the shell space and seals against atmosphere the medium flowing on the shell side.

On the tube side the connection or guide chamber attached directly to the movable tubesheet is also sealed against atmosphere by means of suitable flat seals.

The tube/tubesheet connections are produced by appropriate tube expand rollings or tube weldings in accordance with the construction regulations, material combinations and operating media as well as the maximum permissible operating parameters (P/T). Naturally, to avoid gap corrosion, after a tube welding the internal tubes are roll expanded again.

The connection and guide chambers are available in different versions, which can be produced by a tube side single-pass or a multi-pass design and whose selection is effected in accordance with the standards required and in accordance with fluid engineering aspects.

Venting and draining points as well as a corresponding base construction are designed in relation to the installation position.

Material selection

In accordance with the respective regulations, construction regulations and operating media, carbon steels, stainless steels as well as nonferrous heavy metals are used. A reasonable integration of special materials, platings and coatings is possible.

Application

This heat exchanger type C 100 is mainly used where, in addition to the requirement for a removable tube bundle and good cleaning possibilities, a higher quality for the tube side sealing type is required in relation to the operating media, pressure and temperature. Due to its boundary conditions it is highly suitable for fluid operating media but also as a gas cooler with and without partial condensation; however, critical media should flow on the tube side.

Acceptance

The FUNKE heat exchanger type C 100 can be supplied in accordance with all pertinent national and international certification bodies, regulations and construction regulations as e.g. pursuant to the Pressure Equipment Directive (PED), AD-2000, ASME-VIII, Div. I, U-Stamp, TEMA standard, CHINA-SQL. The integration of works standards or customer specifications is no problem either.

Boundary conditions

Due to its design and sealing type the maximum permissible operating conditions* are

	Shell side	Tube side
Maximum operating overpressure	21 bar	41 bar
Maximum operating temperature	320°C	250°C

* The maximum values may reduce due to regulations, works standards and construction regulations!

Universal cooler, fixed tube bundle

Model series C 200 (e.g TEMA Type BEM, AEM, NEM)

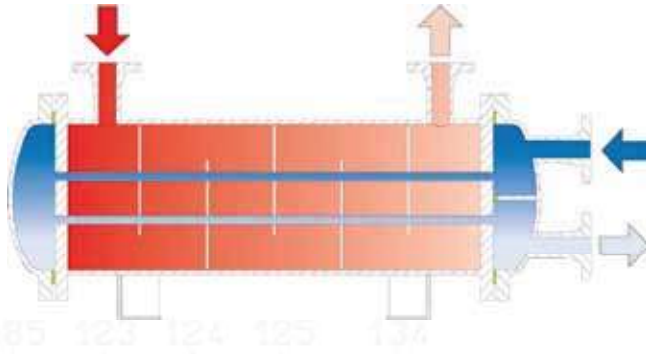

Technical Description

The FUNKE heat exchanger type C 200 is a heat exchanger with straight internal tubes and a fixed non-removable tube bundle whose shell is welded to the tubesheets, forming a tight seal.

Due to its design this heat exchanger may be equipped with maximum tubing. The tube/tubesheet connections are produced by appropriate tube expand rollings or tube weldings in accordance with the construction regulations, material combinations and operating media as well as the maximum permissible operating parameters (P/T). Naturally, to avoid gap corrosion, after a tube welding the internal tubes are roll expanded again. Depending on the actual application a thermal stress of the shell tube can be eliminated by installing an axial compensator.

The connection and guide chambers are available in various different designs by means of which a tube side single-pass or multi-pass version can be produced.

Venting and draining points as well as a corresponding foot construction are designed in relation to the installation position.

Material selection

In accordance with the respective regulations, construction regulations and operating media, carbon steels, stainless steels as well as nonferrous heavy metals are used. A reasonable integration of special materials, platings and coatings is possible.

Application

This heat exchanger type C 200 can universally be used. Taking into account its design characteristics it can be applied for cooling and heating fluids, gases and vapours as well as for condensation and in vacuum operation.

An individual media routing permits operation even at high operating pressures, contaminated operating media should preferably flow on the tube side.

Acceptance

The FUNKE heat exchanger type C 200 can be supplied in accordance with all pertinent national and international certification bodies, regulations and construction regulations as e.g. pursuant to the Pressure Equipment Directive (PED), AD-2000, ASME-VIII, Div. 1/II, U-Stamp, TEMA standard, CHINA-SQL. The integration of works standards or customer specifications is no problem either.

Universal cooler, U-tube-bundle removable

Model series C 300 (e.g. TEMA Type BEU, AEU, BFU, AFU, BXU, AXU)

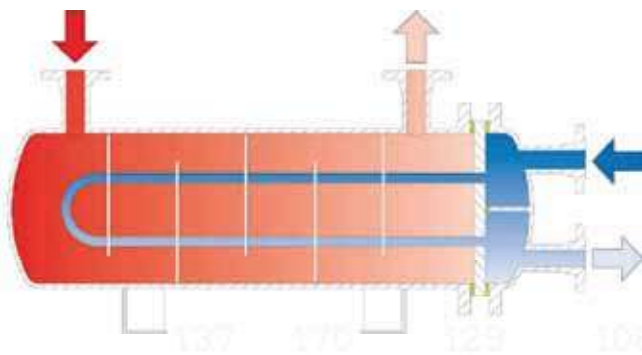

Technical Description

The FUNKE heat exchanger type C 300 is a heat exchanger with removable U-tube-bundle whose fixed tubesheet is clamped in between the shell side and tube side device flanges by means of two flat seals and bolts.

The tube/tubesheet connections of the internal tubes bent in U-shape will be produced by appropriate tube expand rollings or tube weldings in accordance with the construction regulations, material combinations and operating media as well as the maximum permissible operating parameters (P/T). Naturally, to avoid gap corrosion, after a tube welding the internal tubes are roll expanded again.

The connection chamber is available in different versions, which can be produced by a tube side two-pass or multi-pass design and whose selection is effected in accordance with the standards required and in accordance with fluid engineering aspects.

Venting and draining points as well as a corresponding foot construction are designed in relation to the installation position.

Material selection

In accordance with the respective regulations, construction regulations and operating media carbon steels, stainless steels as well as nonferrous heavy metals are used. The reasonable integration of special materials, platings and coatings is possible.

Application

Due to its design this heat exchanger type C 300 can be used universally. The internal tubes bent in a U-shape, which are exclusively attached to the fixed tubesheet, permit operation at very high temperatures and pressures without any thermal stresses, thus avoiding damage occurring on the tube/tubesheet connection. This heat exchanger can be used for the partial or full condensation of gases and vapours but also as a fluid cooler/heater.

On principle the media routing can be freely selected, but the clean operating medium should preferably flow through the tubes as a mechanical cleaning of the internal tubes bent in a U-shape is only limited feasible.

Other design options as e.g. the version with a two-pass shell or as a suction cooler for tank installation expand the operational possibilities of this type.

Acceptance

The FUNKE heat exchanger type C 300 can be supplied in accordance with all pertinent national and international certification bodies, regulations and construction regulations as e.g. pursuant to the Pressure Equipment Directive (PED), AD-2000, ASME-VIII, Div. I/II, U-Stamp, TEMA standard, API 614/618/660, CHINA-SQL. The integration of works standards or customer specifications is no problem either.

Universal cooler, floating head, tube bundle removable Model series C 400 (e.g. TEMA Type AET/BET)

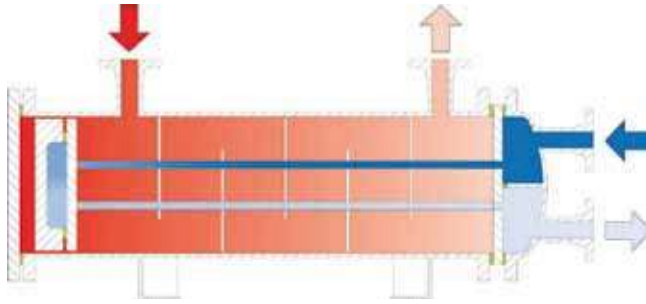

Technical Description

The FUNKE heat exchanger type C 400 is a heat exchanger with straight internal tubes and removable tube bundle whose fixed tubesheet is clamped in between the shell side and tube side device flanges by means of two flat seals and bolts.

In combination with the guide chamber fitted by means of bolts and flat seals to the tubesheet, the movable tubesheet forms the floating head positioned on the inside of the shell. Due to this design the tube bundle can be removed without any disassembly of the guide chamber. For an easy inspection of the floating head in its installation position, the shell is equipped with an inspection cover on this side.

The tube/tubesheet connections are produced by appropriate tube expand rollings or tube weldings in accordance with the construction regulations, material combinations and operating media as well as the permissible operating parameters (P/T). Naturally, to avoid gap corrosion, after a tube welding the internal tubes are roll expanded again.

The connection chamber is available in different versions so that a multi-pass design can be produced exclusively and whose selection is effected in accordance with the standards required and in accordance with fluid engineering aspects.

Venting and draining points as well as a corresponding foot construction are designed in relation to the installation position.

Material selection

In accordance with the respective regulations, construction regulations and operating media, carbon steels, stainless steels as well as nonferrous heavy metals are used. A reasonable integration of special materials, platings and coatings is possible.

Application

This heat exchanger type C 400 is mainly used where, in addition to the requirement for an removable tube bundle and good cleaning possibilities, a higher quality for the sealing type is required in relation to the operating media, pressure and temperature.

Acceptance

The FUNKE heat exchanger type C 400 can be supplied in accordance with all pertinent national and international certification bodies, regulations and construction regulations as e.g. pursuant to the Pressure Equipment Directive (PED), AD-2000, ASME-VIII, Div. I, U-Stamp, TEMA standard, CHINA-SQL. The integration of works standards or customer specifications is no problem either.

Universal cooler, floating head, tube bundle removable

Model series C 500 (e.g. TEMA Type AES; BES)

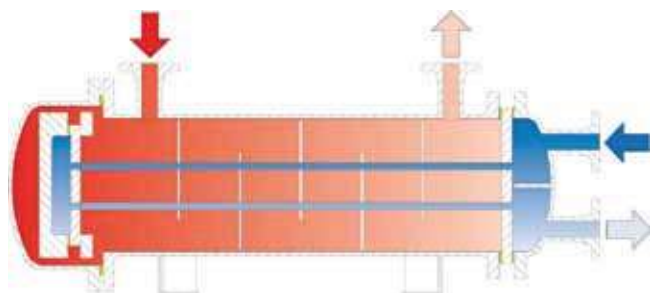

Technical Description

The FUNKE heat exchanger type C 500 is a heat exchanger with straight internal tubes and removable tube bundle whose fixed tubesheet is clamped in between the shell side and tube side device flanges by means of two flat seals and bolts.

In combination with the guide chamber fitted by means of a split ring, bolts and flat seals to the tubesheet, the movable tubesheet forms the floating head positioned on the inside. Due to this design the tube bundle can be equipped with a maximum heat exchange surface. This floating head is enclosed by a shell chamber with extended diameter which is removable to allow inspection of the floating head. For a tube side single-pass design the corresponding connection flange is routed through this chamber and sealed by means of a stuffing box gland. It is possible to install an axial compensator within this shell chamber.

The tube/tubesheet connections are produced by appropriate tube expand rollings or tube weldings in accordance with the construction regulations, material combinations and operating media as well as the permissible operating parameters (P/T). Naturally, to avoid gap corrosion, after a tube welding the internal tubes are roll expanded again.

Different designs of the connection chamber on the fixed tubesheet are available whose selection is effected in accordance with the standards required and in accordance with fluid engineering aspects and the tube side number of passes (single-pass/multi-pass).

Venting and draining points as well as a corresponding foot construction are designed in relation to the installation position.

Material selection

In accordance with the respective regulations, construction regulations and operating media, carbon steels, stainless steels as well as nonferrous heavy metals are used. A reasonable integration of special materials, platings and coatings is possible.

Application

This heat exchanger type C 500 is mainly used where, in addition to the requirement for a removable tube bundle and good cleaning possibilities, maximum quality is required. This design is primarily used in the chemical and petrochemical industries as well as in vacuum engineering as process gas cooler, oil cooler or as a condenser/vacuum condenser.

Acceptance

The FUNKE heat exchanger type C 500 can be supplied in accordance with all pertinent national and international certification bodies, regulations and construction regulations as e.g. pursuant to the Pressure Equipment Directive (PED), AD-2000, ASME-VIII, Div. I/II, U-Stamp, TEMA standard, API 614/618/660, CHINA-SQL. The integration of works standards or customer specifications is no problem either.



**Quality work for reliable
and economical heat exchangers**





Our core competency

is in our consistently customer-oriented design and calculation:
 Process engineering, thermodynamics, stress calculation, vibration analysis

Calculation regulations, design regulations, construction regulations and acceptance regulations as well as standards pursuant to which FUNKE already supplies:

- ASME VIII, Div. 1 & 2; U-Stamp
- AD 2000, in particular HP0/DIN EN 729-2
- American Bureau of Shipping (ABS)
- American Petroleum Institute (API)
- Australian Standard 1210 (AS 1210)
- British Standard PD 5500
- Bureau Veritas (BV)
- CODAP 2000
- Det Norske Veritas (DNV)
- DIN EN 13445
- EU pressure systems directive 97/23/EC
- Germanischer Lloyd (GL)
- Heatexchanger Institute (HEI)
- Heat Transfer Research, Inc. (HTRI)
- Lloyds Register of Shipping (LRS)
- NACE-Standard
- Stoomwezen (NL)
- Swedish Pressure Vessel Code (SPVC)
- TEMA-Standards
- VDI-Wärmeatlas
- Welding-Research-Councils, Bulletin 107 (WRC 107)
- ... and others.



FUNKE is certified supplier for:

ARAMCO	OMV
BASF	SABIC
BAYER	SIEMENS
BOREALIS	TECHNIP
DOW	UHDE
LINDE	... and others

Leading standards like TEMA are part of our team

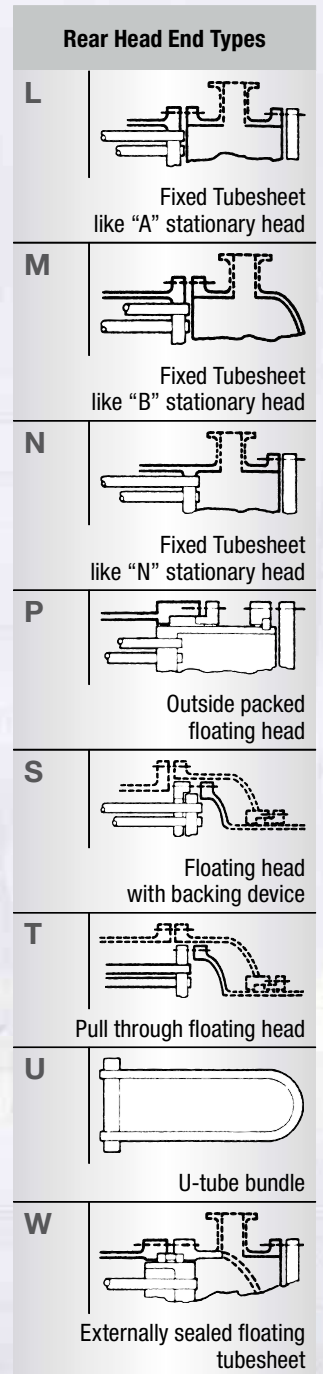
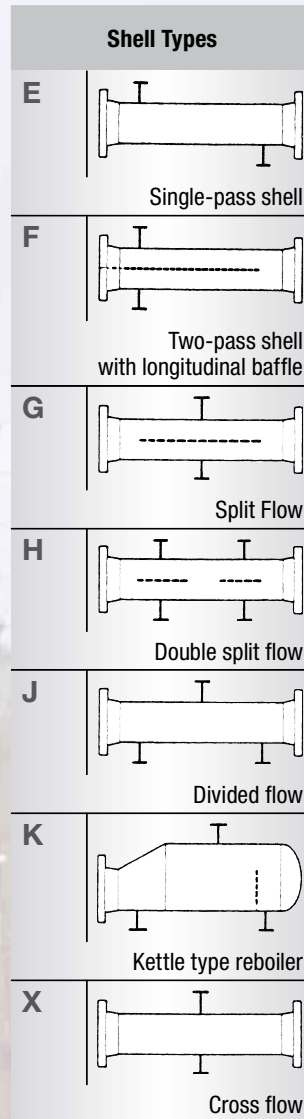
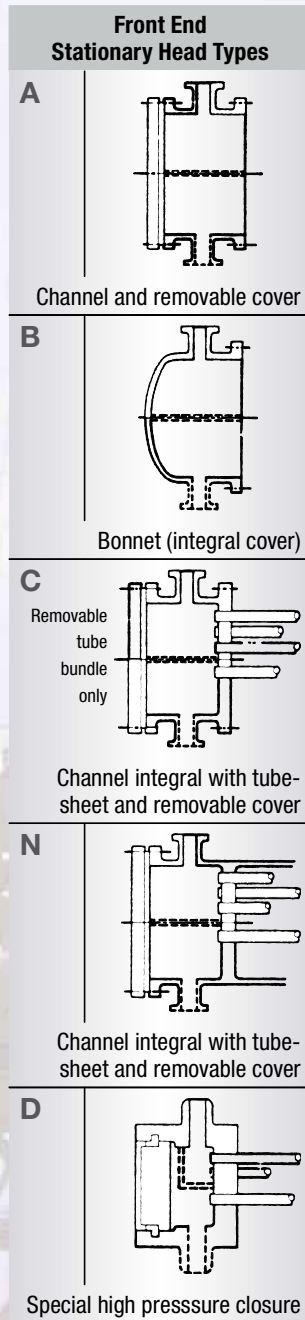

The "Recommended Good Practice" recommendations from the TEMA* standard provide the basis for the heat transfer calculation and dimensioning of FUNKE shell-and-tube heat exchangers, also for the most demanding designs.

Our experience and the know-how from our more than 30 years of membership in Heat Transfer Research Inc. (HTRI) and the use of their worldwide recognised design software for the heat transfer engineering and decades of experience in the constructive stress- and load calculations provide the basis for the manufacture of our high quality shell-and-tube heat exchangers.

The quality standards, construction regulations, works standards or project specifications of our customers flow into our project engineering in the same way as our own requirement for maximum plant safety and efficiency.

In addition, comprehensive internal and external quality controls from the incoming goods department to the shipping department ensure that the product manufactured achieves a maximum degree of customer satisfaction in terms of function, quality and documentation.

* Tubular Exchanger Manufacturers Association, Inc.

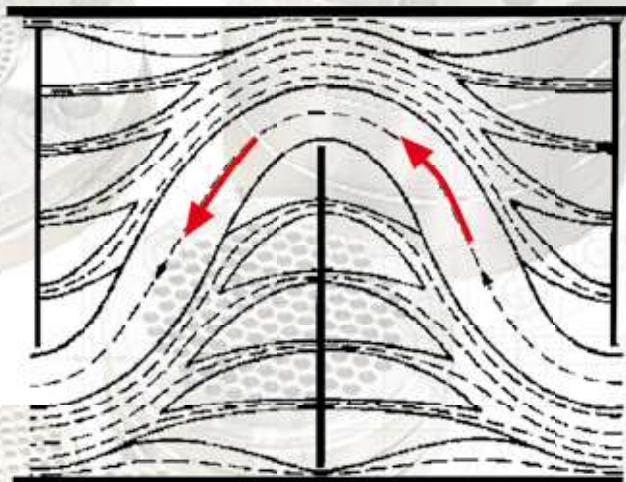

Customers rely on the consistent quality orientation of FUNKE
– at 600 bar and higher every welding seam counts



Ship engine cooling



Lubricant cooling



Oil supply system



High performance pumps



Process gas cooling



Compressed air cooling

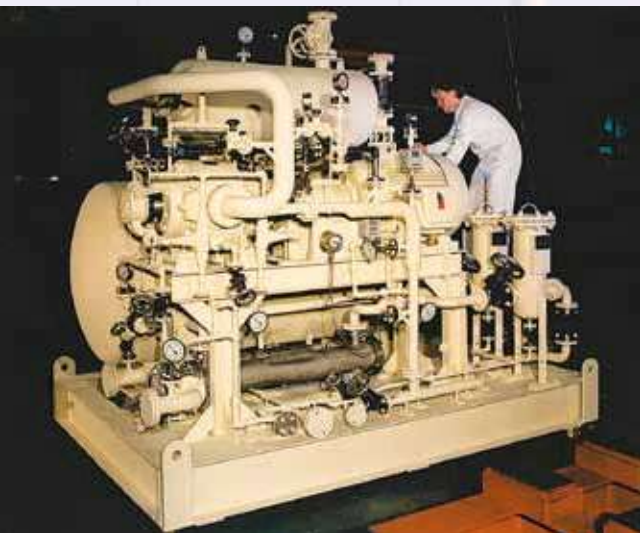

Sulphuric acid



Methanol cooling

Allweiler

Andritz

Bosch Rexroth

Burckhardt Compression

Coperion

Dow Chemical

Flender

Hayward Tyler

Nash Elmo

Linde

Neumann & Esser

Dresser Rand

Sulzer

Uhde

Voith

Zeppelin

Quality means safety. Each unit built by FUNKE is design and pressure tested. Additional approvals are also available in accordance with quality authorities such as:



- American Bureau of Shipping (ABS)
- Bureau Veritas (BV)
- Det Norske Veritas (DNV)
- Germanischer Lloyd (GL)
- Lloyds Register of Shipping (LRS)
- Schweizerischer Verein für technische Inspektionen (SVTI)
- Technischer Überwachungsverein (TÜV)

as well as customers' test and inspection regulations.

FUNKE has been certified according to DIN EN ISO 9001:2008 and is an approved manufacturer according to:

- EU Pressure Equipment Directive 97/23/EC (PED), Module H/H1
- HP0 in connection with DIN EN 729-2
- ASME U-Stamp
- GOST R (incl. RTN & hygiene certificate)
- China Certificate

www.funke-tr.com



FUNKE



Funke Wärmeaustauscher Apparatebau GmbH
Zur Dessel 1
31028 Gronau/Leine · Germany

Funke Industrial - Türkiye
MDTHEX MÜHENDİSLİK HİZMETLERİ LTD.
ŞTİ
İletişim Bilgileri
Adres: Maltepe Mah. Davutpaşa Kışla Cad.
Kale İş Merkezi, A Blok No:63,
Topkapı-Zeytinburnu İstanbul
Tel: 0212 482 90 03
Fax: 0212 48290 04
Mbl: 0535 355 05 34
Web: www.mdthex.com